

Accessories

Description	Part#	Length	Gauge	Girth	Lbs.
 Low Profile Ridge Vent	LPRV	10'-0"	26		45#
	LPRVEC	(ENDS)			0.5#

 Vents	Gauge	Weight	Size
	26	115#	9" x 10'
	26	150#	12" x 10'
	Lever Handle Operator Kit (Optional)		
	Kit includes 2 vent pulleys		
	Kit includes 1 vent cable clamp (3/16")		
	Kit includes 1 cable clamp		
	Kit includes 40' if 3/16" cable		

Polycarbonate, Light Transmitting

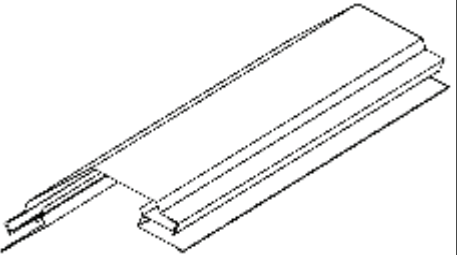
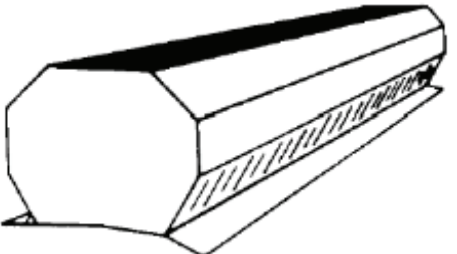

Description	Length	Color	In Stock
"R" panel	11'-0"	White	W/Screws
"R" panel	11'-0"	Clear	W/Screws

Die form Ridge Cap

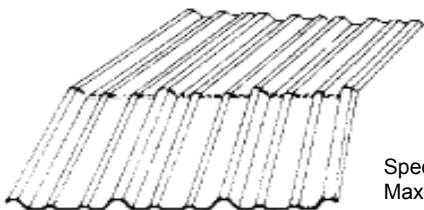

Specify Slope
Maximum roof slope: 6:12

Type	Length	Weight
"R" panel	2'-6"	7.59#
"R" panel	3'-0"	9.00#





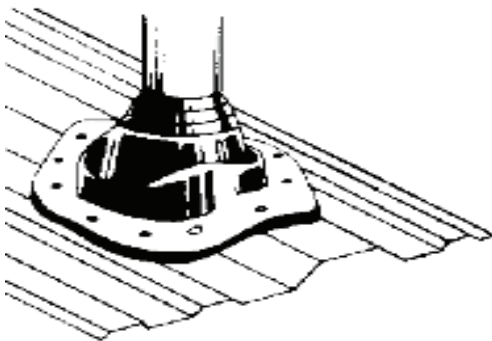

Accessories

Roof Jacks



Part Number	Temp Range	Pipe Size
RJ-5	-65/+250	1/4" - 4"
RJ-5	-65/+250	4" - 7"
Retrofit Type	Special Order	Special Order
RJ-7	-65/+250	6" - 11"
Hi-Temp	Special Order	Special Order
*Other Sizes available by Special Order Only.		

Closures

	Description	Type	Carton Quantity	Size
	"R" panel closure	Inside	100	1" x 3'-0"
	"R" panel closure	Outside	100	1" x 3'-0"
	"U" panel closure	Inside	100	1" x 3'-0"
	"U" panel closure	Outside	100	1" x 3'-0"
	Storm Master	Inside	100	1" x 3'-0"
	Storm Master	Outside	100	1" x 3'-0"

Accessories

Tape Seal



Description	Carton Quantity
3/32" x 3/8 x 45'	40
3/32" x 1" x 45'	20
7/8" x 3/16 x 25' Double Bead	8 Sold by carton only
9" x 33" Peel & Seal Adhesive Flashing	Sold by 33' rolls

Caulk

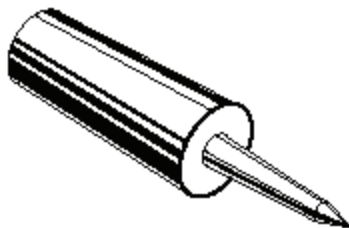

Urethane/Tubes	Carton Quantity
White	30
Limestone	30
Gray	30
Bronze	30
Almond	30
Narrow Joint Sealer Gutter Caulk	Carton Quantity
Aluminum	30
White	30

Accessories

Fasteners



Self-Drilling Screws for use in attaching metal to metal.



Stitch Screws used for stitching laps and attaching trim.



Wood Grip Screws for use in attaching metal to wood.

Self-Drilling Screws	Size	Pounds per 1000
Self-Drilling Screws	#12 x 1-1/4"	15.2#
Stitch Screws	#14 x 7/8"	15.1#
Wood Grip Screws	#9 x 1-1/2"	9.5#
Long Life Screws (Zac)	#12 x 1-1/4"	24.3#
Long Life Screws (Zac)	#14 x 7/8"	24.8#
Pop Rivets S/S	1/8" Diameter	3.3#
Type A Self-Tapping	#14 x 1-1/2"	20.6#
Self-Drilling Screws w/o washers	1/4-14 x 7/8"	10.4#
Self-Drilling Screws w/o washers	12-14 x 1"	10.0#
#2 Phillips Pancake Head Driller	10 x 1"	7.7#
#2 Phillips Pancake Head Type A	10 x 1"	7.1#
Tek 4.5 with Washer	12-24 x 1-1/4"	12.6#
Tek 4.5 without Washer	12-24 x 1-1/4"	11.4#
Expansion Anchors	1/2" x 2-3/4"	170.0#
Nail-in Drive Anchors	1/4" x 1-1/4"	25.0#
*Stocked in all colors and stitch plated. **Stocked in plated only		

Accessories

Bolts



All bolts include nuts and are plated unless noted.

*Available in Plated full Thread
**Black Only

	Size	Pounds per 100
A325 Structural Bolts	1/2 x 1-1/4"	11.2#
	*1/2 x 2"	15.4#
	5/8 x 1-3/4"	23.1#
	*5/8 x 2"	25.5#
	3/4 x 2"	39.0#
	3/4 x 2-1/4"	42.3#
	*3/4 x 2-1/2"	45.4#
	3/4 x 2-3/4"	48.0#
	7/8 x 2-1/4"	60.6#
	7/8 x 2-1/2"	64.9#
	7/8 x 2-3/4"	69.1#
	*7/8 x 3"	73.3#
	1 x 2"	76.5#
	**1 x 2-1/4"	81.5#
	1 x 2-1/2"	87.5#
	**1 x 2-3/4"	92.5#
**1 x 3"	98.0#	
A307 Light Structural Bolts	1/2 x 1-1/4"	10#
Button Head Bolts	1/2 x 1"	9.5#

Accessories

Bracing Hardware

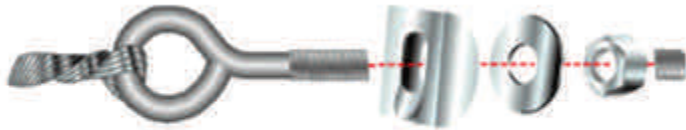

Cable Bracing

Cable Bracing Assemblies include:
eyebolt, hillside washers, flat
washers and nuts.

Note: to determine the correct
assembly size, multiply the cable
size x 2.

Size	Pounds per 100
1/2"	100
5/8"	166
3/4"	227



Rod Bracing

Rod Bracing Assemblies include:
hillside washers, flat washers and
nuts.

Size	Pounds per 100
1/2"	34
5/8"	50
3/4"	61
7/8"	89
1"	128

Accessories

Cable



Size	Max. breaking strength in lbs.	Pounds per 100 ft
1/4"	6,650	12.1
5/16"	11,200	20.5
3/8"	15,400	27.3

Flo-Loc Grips



Size	Max. breaking strength in lbs.	Length
1/4"	6,650	19-1/2"
5/16"	11,200	21"
3/8"	15,400	26"

Eye bolts with Nuts



Size	Thread Length	Yield strength in lbs.
1/2"	6"	36,000
5/8"	6"	55,000
3/4"	6"	55,000

Hillside and Flat Washer



Size	Type	Finish
1/2"	Flat	Plated
5/8"	Flat	Plated
3/4"	Flat	Plated
1/2"	Hillside	Black
5/8"	Hillside	Black
3/4"	Hillside	Black
7/8"	Hillside	Black
1"	Hillside	Black

Accessories

Brace Rods

Note: All threads can be made right hand or left hand. Please indicate using RH or LH.

All threads are made using 10 threads per inch standard.

Size-Diameter	Weight per ft.
1/2"	.067
5/8"	1.04
3/4"	1.50
7/8"	2.04
1"	2.66

Windows

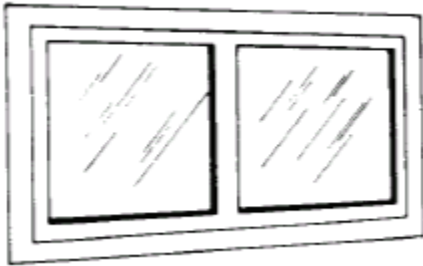

Non—Insulated		
Size	Type	Weight
3030	Horizontal Slide With half screen	27#
4030	Horizontal Slide With half screen	36#
6030	Horizontal Slide With half screen	50#

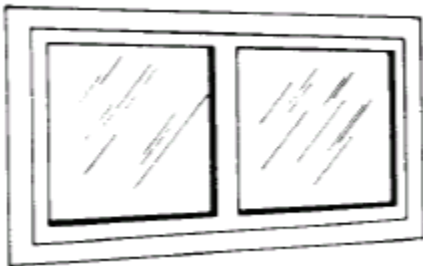

Insulated		
Size	Type	Weight
3030	Horizontal Slide With half screen	27#
4030	Horizontal Slide With half screen	36#
6030	Horizontal Slide With half screen	50#



Accessories

Doors



Type M



Type SL

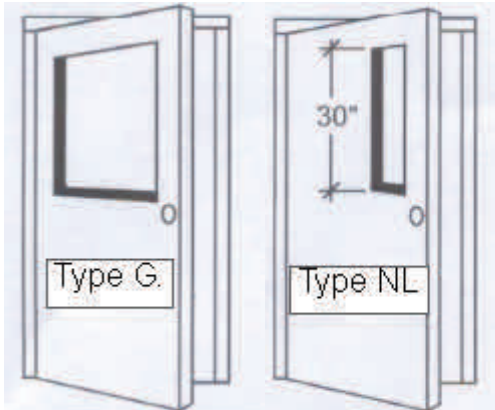

Size	Type	Finish	Weight
3070	M	White	215#
*3070	NL	White	195#
*3070	SL	White	195#
3070	G	White	195#
4070	M	White	273#
*4070	NL	White	248#
6070	M	White	330#
*6070	NL	White	300#

Notes:

1. 3070 and 4070 price includes leaf, frame, hinges, and threshold.
2. 6070 price includes leaf, frame, hinges, astragal, cover plate for inactive leaf, head bolts, foot bolts, and threshold.
3. Prices do not include glass, lockset, or weather strip.
4. Metal doors are designed for lever locksets. For knob locksets used in residential and agricultural applications, a special door leaf must be ordered.
5. ADA regulations require lever locksets for public access buildings.

3070 Weather strip

4070 Weather strip

6070 Weather strip

Study Duty Deadbolt Lock

Study Duty Lever Handle Lock

3070 Universal Threshold

4070 Universal Threshold

6070 Universal Threshold

Door Closer

6070 Removable Mullion

Anti-Panic surface mount w/Lever